

IS471F

OPIC Light Detector with Built-in Signal Processing Circuit for Light Modulation System

■ Features

1. Impervious to external disturbing lights due to light modulation system
2. Built-in pulse driver circuit and sync. detector circuit on the emitter side
3. A wide range of operating supply voltage (V_{CC} : 4.5 to 16V)

■ Applications

1. Optoelectronic switches
2. Copiers, printers
3. Facsimiles

■ Outline Dimensions

(Unit : mm)

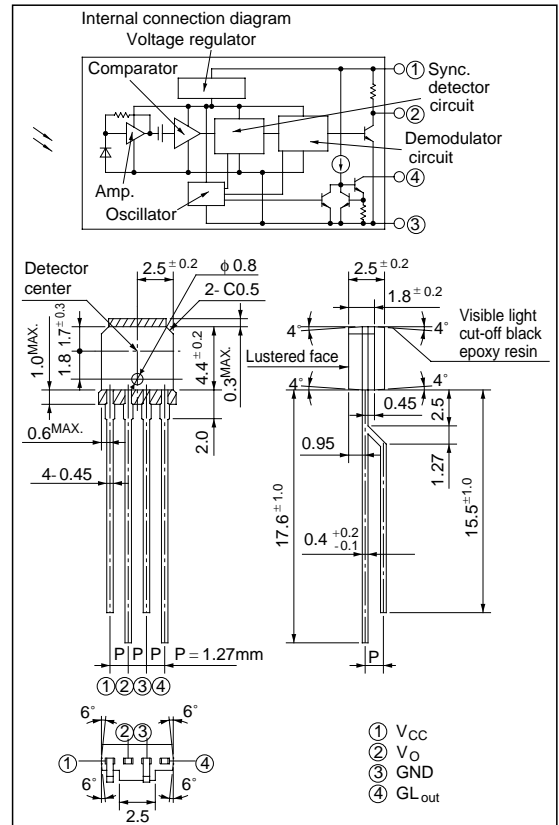

*"OPIC" (Optical IC) is a trademark of the SHARP Corporation.
An OPIC consists of a light-detecting element and signal-processing circuit integrated onto a single chip.

■ Absolute Maximum Ratings

(Ta= 25°C)

Parameter	Symbol	Rating	Unit	
Supply voltage	V_{CC}	-0.5 to 16	V	
Output	Output voltage	V_O	16	V
	Output current	I_O	50	mA
*1 GL output	Output voltage	V_{GL}	16	V
Power dissipation	P	250	mW	
Operating temperature	T_{opr}	-25 to +60	°C	
Storage temperature	T_{stg}	-40 to +100	°C	
*2 Soldering temperature	T_{sol}	260	°C	

*1 Applies to GL_{out} terminal

*2 For 5 seconds at the position shown in the right figure

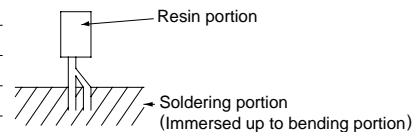

Electro-optical Characteristics

($V_{CC}= 5V, T_a= 25^{\circ}C$)

Parameter		Symbol	Conditions	MIN.	TYP.	MAX.	Unit
Operating supply voltage		V_{CC}	-	4.5	-	16	V
Supply current		I_{CC}	V_O, GL_{out} terminals shall be opened.	-	3.5	7.0	mA
Output	Low level output voltage	V_{OL}	$I_{OL}= 16mA, E_{VP}= 500lx, E_{VD}= 0^{*3}$	-	0.15	0.35	V
	High level output voltage	V_{OH}	$E_{VD}= E_{VP}= 0^{*3}$	4.97	-	-	V
	Output short circuit current	I_{OS}	$E_{VP}= E_{VD}= 0^{*3}$	0.25	0.5	1.0	mA
GL output	Low level output current	I_{GL}	$V_{GL}= 1.2V$	40	55	70	mA
	^{*4} Pulse cycle	t_p	-	70	130	220	μs
	^{*4} Pulse width	t_w	-	4.4	8	13.7	μs
^{*5} "Low→High" threshold irradiance		E_{ePLH}	$E_{eD}= 0^{*3}$ Light emitting diode ($\lambda_p= 940nm$) ^{*6}	-	0.4	2.66	$\mu W/mm^2$
^{*5} "High→Low" threshold irradiance		E_{ePHL}		-	0.7	2.8	$\mu W/mm^2$
Hysteresis		E_{ePLH}/E_{ePHL}		0.45	0.65	0.95	-
Response time	"High→Low" propagation delay time	t_{PHL}	^{*6}	-	400	670	μs
	"Low→High" propagation delay time	t_{PLH}	^{*6}	-	400	670	μs
^{*7} External disturbing light illuminance		E_{VDX}	$E_{ep}= 7.5 \mu W/mm^2, ^{*3} \lambda_p= 940nm$	2000	7500	-	lx

^{*3} E_{eP} represents illuminance of signal light in sync with the low level timing of output at GL_{out} terminal.

E_{eD} represents illuminance of DC light. For detail, see Fig. 1.

Light source: Infrared light emitting diode ($\lambda_p= 940nm$)

E_{VP} represents illuminance of signal light in sync with the low level timing of output at GL_{out} terminal.

E_{VD} represents illuminance of DC light. Note that the light source is CIE standard light source A.

Fig.1

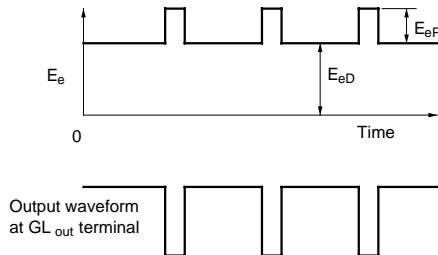

(Note) Fig. 1 shows the output waveform at GL_{out} terminal with **IS471F** connected as shown in Fig. 3.

^{*4} Pulse cycle (t_p), pulse width (t_w) are defined as shown in Fig. 2.

The waveform shown in Fig. 2 is the output voltage waveform at GL_{out} terminal with **IS471F** connected as shown in Fig. 3

Fig.2

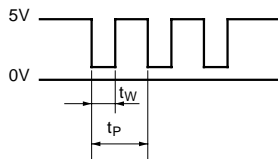
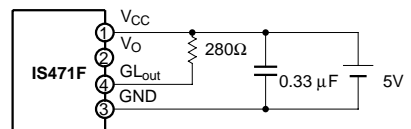

Fig.3



^{*5} Defined as E_{ep} that causes the output to go " Low to High" (or " High to Low").

*6 Test circuit for response time, threshold irradiance is shown in Fig. 4.

Fig. 4

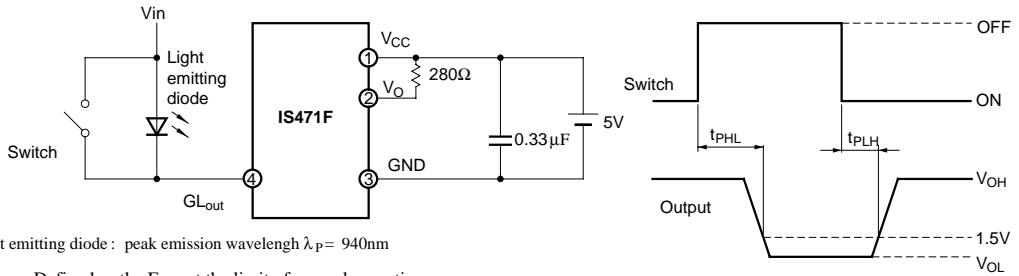

*7 E_{VDX} : Defined as the E_{VD} at the limit of normal operation range.

Fig. 5 Power Dissipation vs. Ambient Temperature

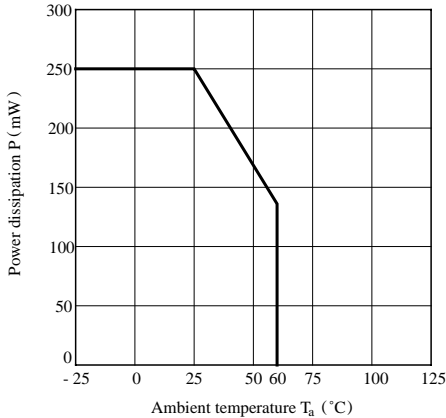

Fig. 6 Low Level Output Voltage vs. Low Level Output Current

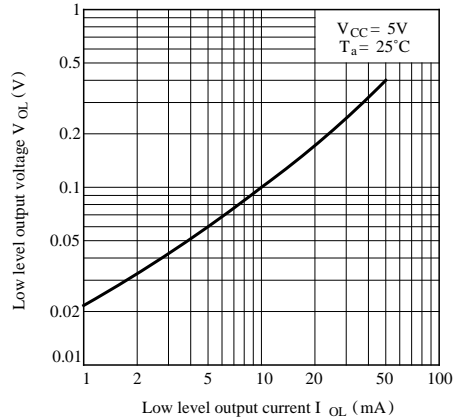

Fig. 7 Low Level Output Voltage vs. Ambient Temperature

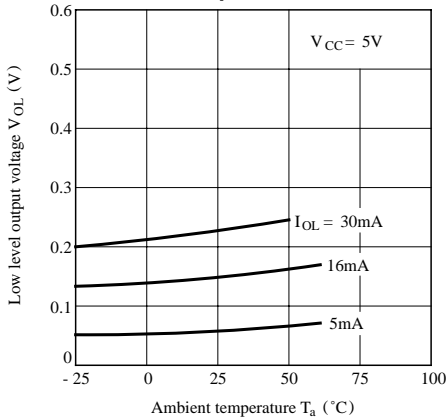

Fig. 8 Supply Current vs. Supply Voltage

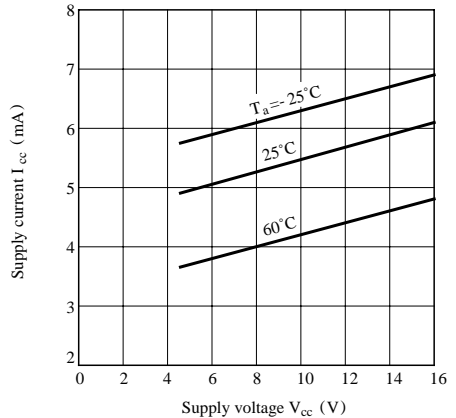

Fig. 9 Low Level Output Current vs. Supply Voltage

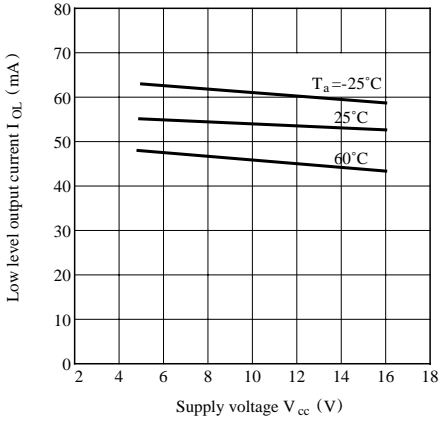

Fig.10 Sensitivity Diagram ($T_a = 25^\circ\text{C}$)

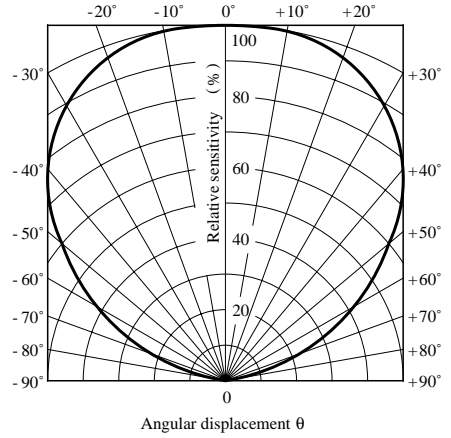
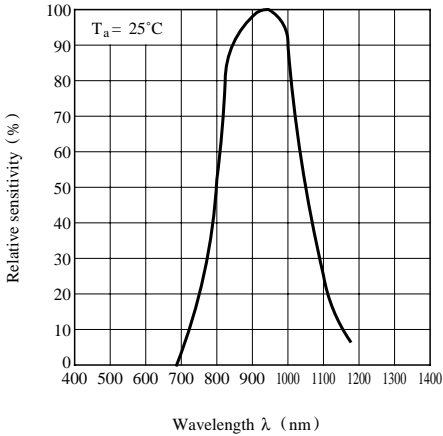
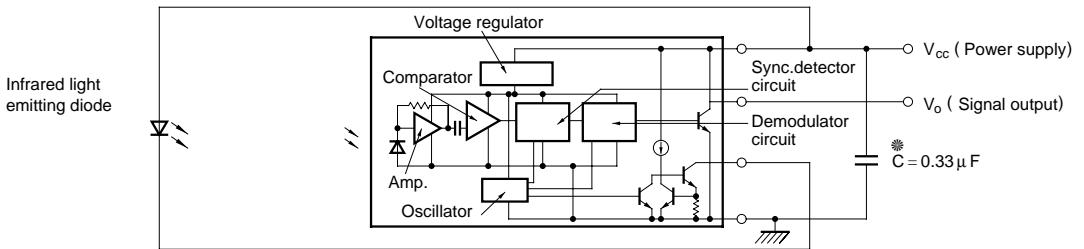

Fig.11 Spectral Sensitivity



Basic Circuit



* In order to stabilize power supply line, connect a by-pass capacitor of $0.33\mu\text{F}$ or more between V_{cc} and GND near the device.

● Please refer to the chapter "Precautions for Use."

NOTICE

- The circuit application examples in this publication are provided to explain representative applications of SHARP devices and are not intended to guarantee any circuit design or license any intellectual property rights. SHARP takes no responsibility for any problems related to any intellectual property right of a third party resulting from the use of SHARP's devices.
- Contact SHARP in order to obtain the latest device specification sheets before using any SHARP device. SHARP reserves the right to make changes in the specifications, characteristics, data, materials, structure, and other contents described herein at any time without notice in order to improve design or reliability. Manufacturing locations are also subject to change without notice.
- Observe the following points when using any devices in this publication. SHARP takes no responsibility for damage caused by improper use of the devices which does not meet the conditions and absolute maximum ratings to be used specified in the relevant specification sheet nor meet the following conditions:
 - (i) The devices in this publication are designed for use in general electronic equipment designs such as:
 - Personal computers
 - Office automation equipment
 - Telecommunication equipment [terminal]
 - Test and measurement equipment
 - Industrial control
 - Audio visual equipment
 - Consumer electronics
 - (ii) Measures such as fail-safe function and redundant design should be taken to ensure reliability and safety when SHARP devices are used for or in connection with equipment that requires higher reliability such as:
 - Transportation control and safety equipment (i.e., aircraft, trains, automobiles, etc.)
 - Traffic signals
 - Gas leakage sensor breakers
 - Alarm equipment
 - Various safety devices, etc.
 - (iii) SHARP devices shall not be used for or in connection with equipment that requires an extremely high level of reliability and safety such as:
 - Space applications
 - Telecommunication equipment [trunk lines]
 - Nuclear power control equipment
 - Medical and other life support equipment (e.g., scuba).
- Contact a SHARP representative in advance when intending to use SHARP devices for any "specific" applications other than those recommended by SHARP or when it is unclear which category mentioned above controls the intended use.
- If the SHARP devices listed in this publication fall within the scope of strategic products described in the Foreign Exchange and Foreign Trade Control Law of Japan, it is necessary to obtain approval to export such SHARP devices.
- This publication is the proprietary product of SHARP and is copyrighted, with all rights reserved. Under the copyright laws, no part of this publication may be reproduced or transmitted in any form or by any means, electronic or mechanical, for any purpose, in whole or in part, without the express written permission of SHARP. Express written permission is also required before any use of this publication may be made by a third party.
- Contact and consult with a SHARP representative if there are any questions about the contents of this publication.